

CM7060F TYPE

●FEATURE

1. Capable of handling the highest current(up to 5A) of any chip-type common mode filter
2. Noise is greatly suppressed.

●Applications

1. Used for power line noise suppression for any electric devices. Used to counter adapter/battery line noise for relatively large electronic devices such as notebook , stand-alone word processor, etc.

●Shape and Dimension

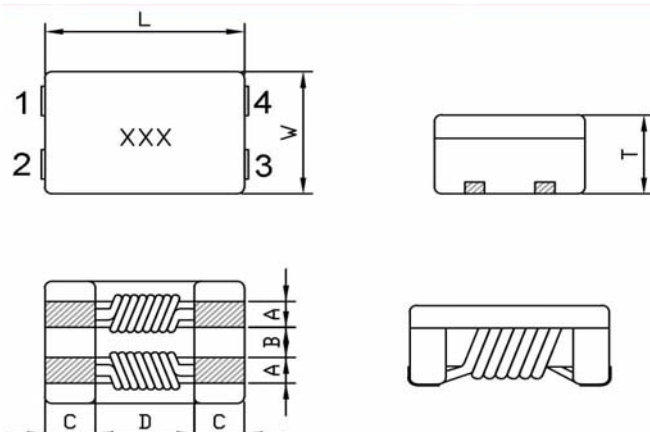

●Schematics and Land Patterns(mm)

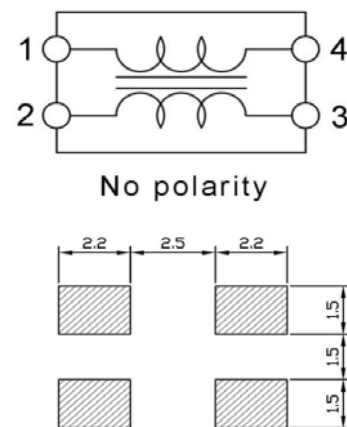

L=7.30±0.30 m/m ; W=6.00±0.20 m/m ; T=3.80 m/m Max ; A=1.50 m/m Ref. ; B=1.50 m/m Ref.
C=1.70 m/m Ref. ; D=3.50 m/m Ref

●Specification

Part number	Common mode Impedance Z(Ω) at 100MHz		DC Resistance (mΩ Max)	Rated Current(A)	Rated Voltage(V)	Insulation Resistance (MΩ)Min
	min	typical				
CM7060F-301	225	300	10	5	80	10
CM7060F-701	500	700	15	4	80	10
CM7060F-102	800	1020	17	3	80	10
CM7060F-132	910	1300	21	2.5	80	10

Note1. Measurement ambient temperature of Impedance, DCR and IDC : at 25°C

Note2. Packing: reel ; Quantity: 1500pcs/reel

● Characteristics

CM7060F-301

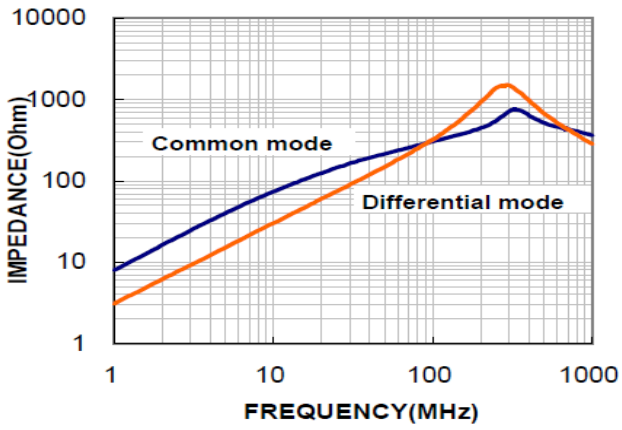

CM7060F-701

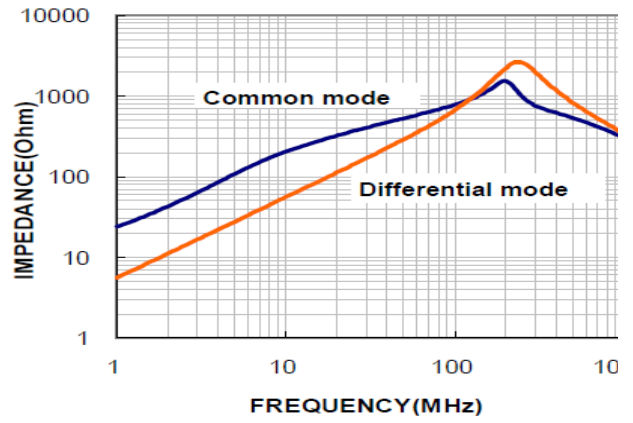

CM7060F-102

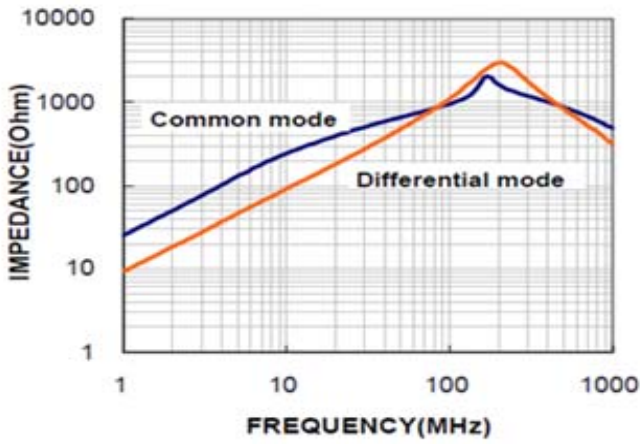

CM7060F-132

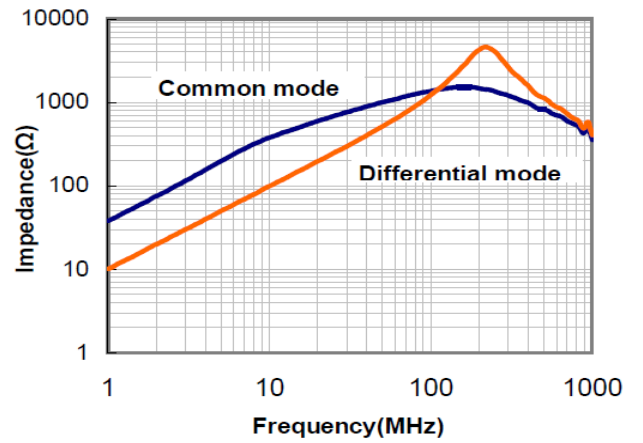

GENERAL CHARACTERISTICS

1. Operating temperature range: -40 TO + 105°C (Includes temperature when the coil is heated)
2. External appearance: On visual inspection, the coil has no external defects.
3. Terminal strength: After soldering. Between copper plate and terminals of coil. Push in two directions of X.Y withstanding at below conditions.

Terminal should not peel off. (refer to figure at right) 5. 0N 60 sec.

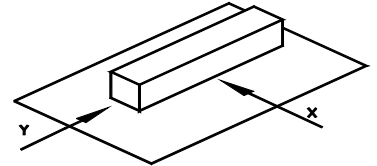

4. Insulating resistance: Over 100MΩ at 100V D.C. between coil and core.
5. Dielectric strength: No dielectric breakdown at 100V D.C. for 1 minute between coil and core.
6. Temperature characteristics: Inductance coefficient $(0\sim 2,000)\times 10^{-6}/^{\circ}\text{C}$ (-25~+80°C), inductance deviation within $\pm 5.0\%$, after 96 hours
7. Humidity characteristics (Moisture Resistance): Inductance deviation within $\pm 5\%$, after 96 hours in 90~95% relative humidity at $40 \pm 2^{\circ}\text{C}$ and 1 hour drying under normal condition.
8. Vibration resistance: Inductance deviation within $\pm 5\%$, after vibration for 1 hour. In each of three orientations at sweep vibration (10~55~10 Hz) with 1.5mm P-P amplitudes.
9. Shock resistance: Inductance deviation within $\pm 5\%$, after being dropped once with 981m/s² (100G) shock attitude upon a rubber block method shock testing machine, in three different orientations.
10. Resistance to Soldering Heat: 260°C, 10 seconds (See attached recommend reflow)
11. Storage environment: Storage condition: Temperature Range: 10°C ~ 35°C (Generally: 21°C ~ 31°C), Humidity Range: 50% ~ 80% RH (Generally: 65% ~ 75%); Transportation condition: Temperature Range: -35°C ~ 85°C, Humidity Range: 50% ~ 95% RH
12. Use components within 12 months. If 12 months or more have elapsed, check solderability before use.
13. Reflow profile recommend:

Lead-free heat endurance test

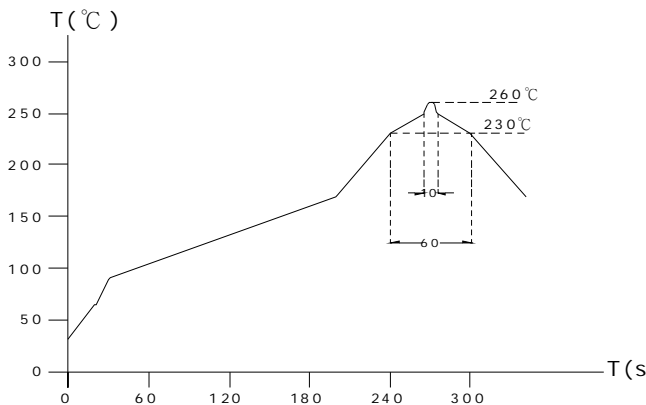

Lead-free the recommended reflow condition

